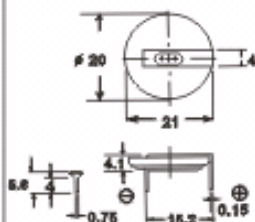
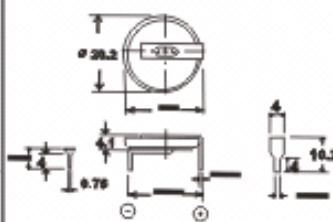

Fig.13



CR203 2TH 22

Fig.14



CR203 2TH 86

Fig.15

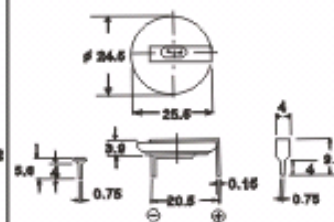

CR243 0TH 26

Fig.16

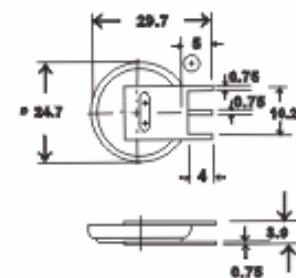

CR243 0 FT V10

Fig.17

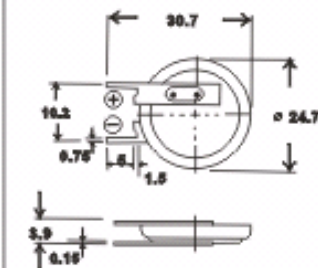

CR243 0 PV30

Fig.18

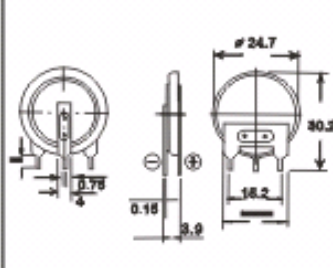

CR243 0T3 V10

Fig.21

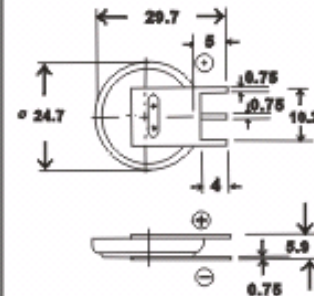

CR246 0 FT V10

Fig.22

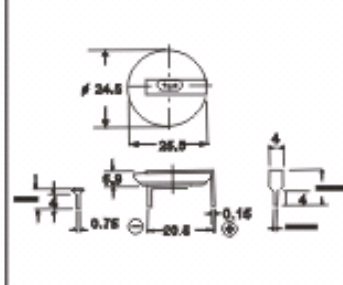

CR246 0TH 26

Fig.19

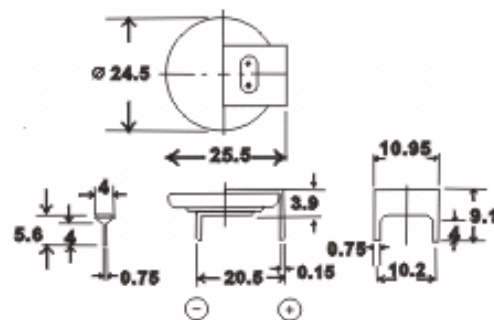

CR243 0 FT H2 6

Fig.20

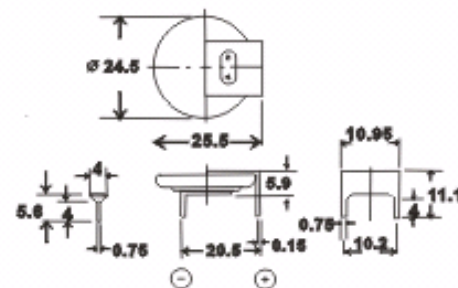

CR246 0 FT H2 6